

INSTRUCTIONS

KAS/KPS (76-83)

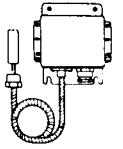

060F9301

060R9301

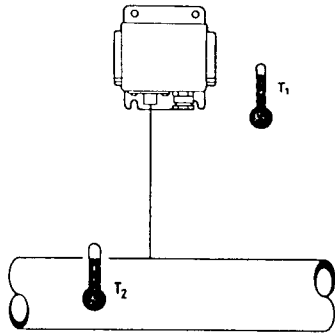
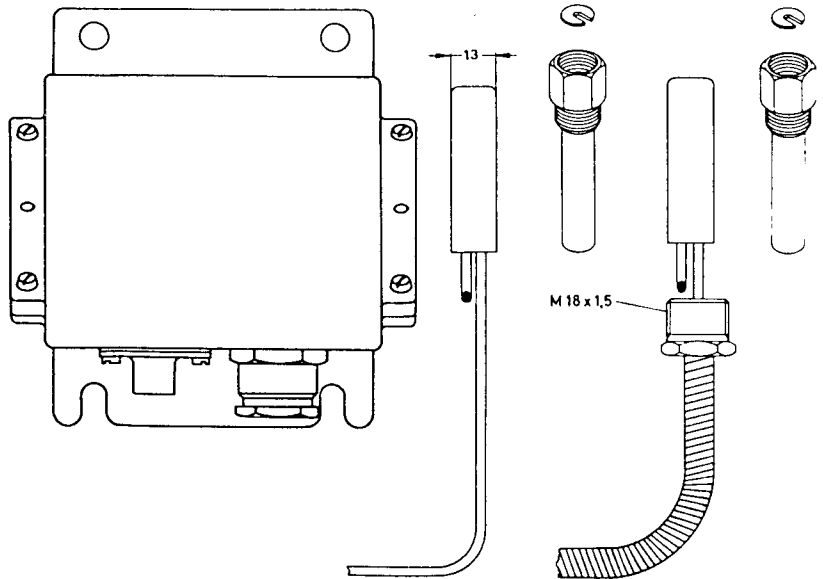
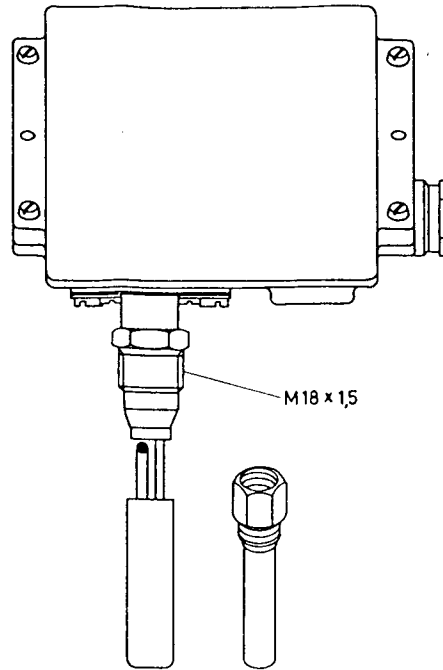
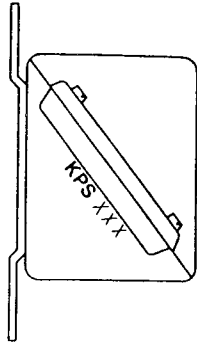

	T ₂ max. (°C)	T ₁ min. (°C)	T ₁ max. (°C)
KPS 76	80	-40	70
KPS 77	130		
KPS 79	200		
KPS 80	220		
KPS 81	250		
KPS 83	300		

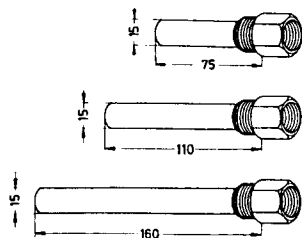

L (mm)	Ms	St. 18/8
75	060L3326	060L3328
110	060L3330	060L3331
160	060L3327	060L3329

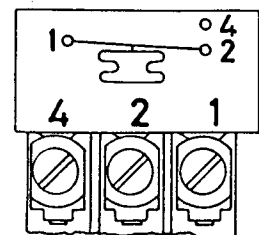

10 (6) A, 440 V ~ L.R. 50 A
220 V, 12 W --- PILOT

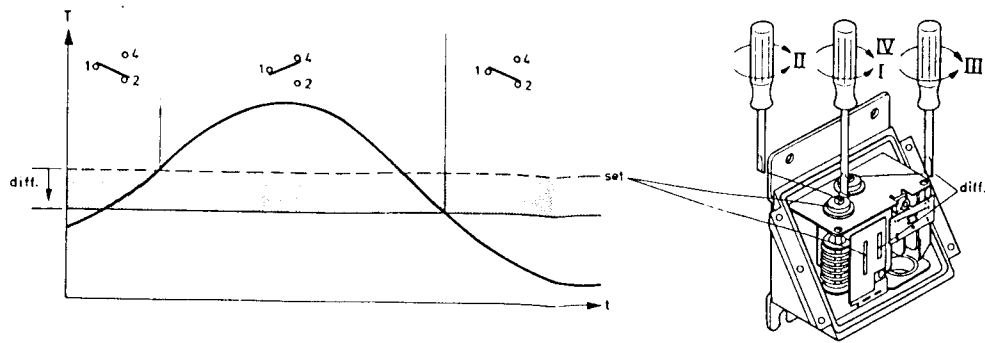

	Diff. (°C)
KPS 79 (060L3141)	9
KPS 83 (060L3139, 060L3140)	18

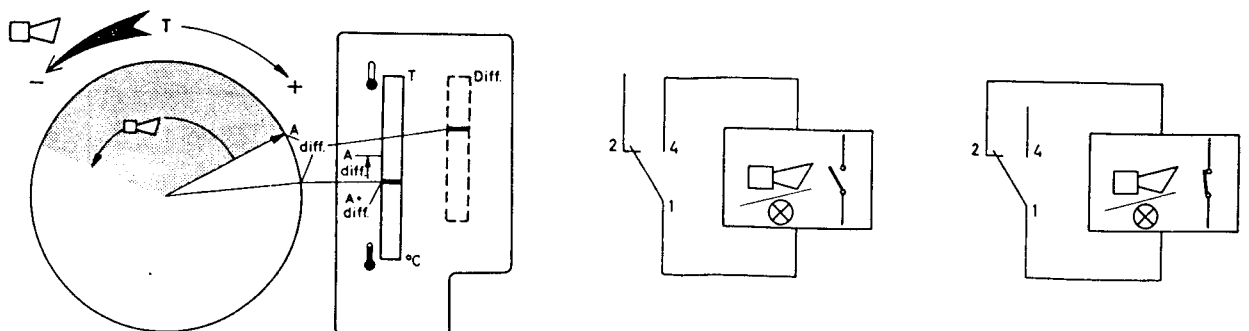
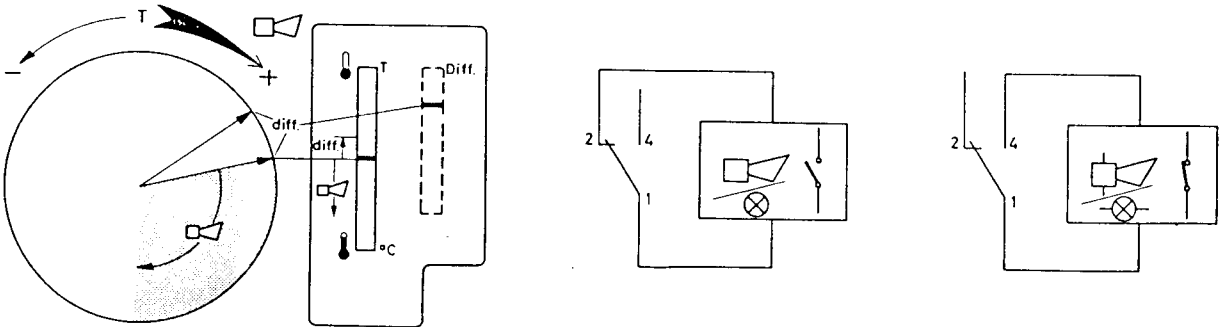
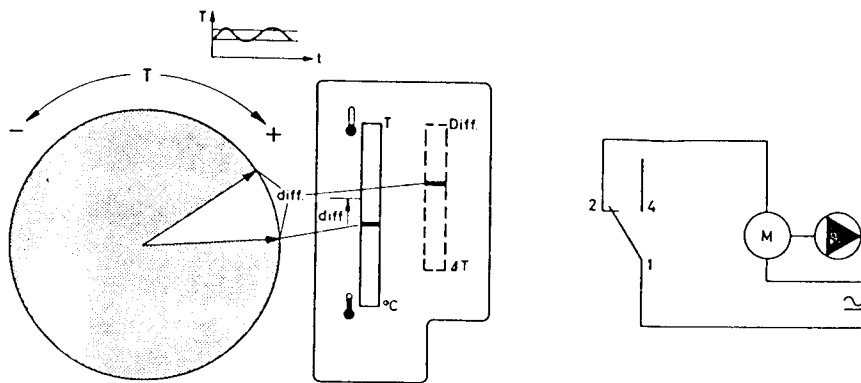

INSTRUCTIONS

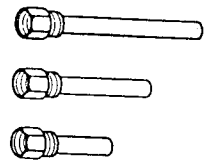

Sensor pocket

060R9307

060R9307

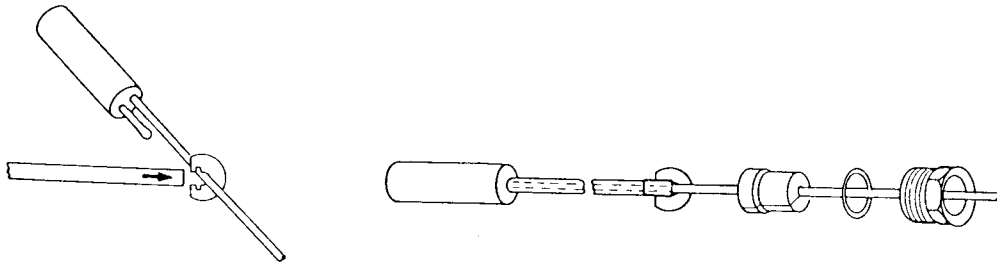
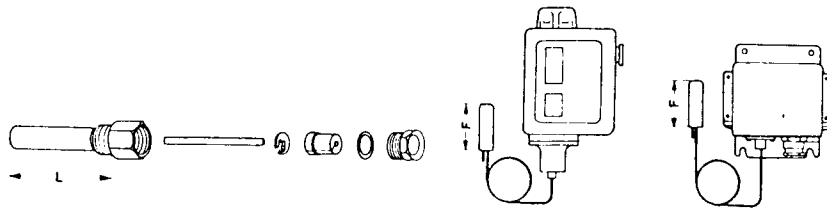

1.

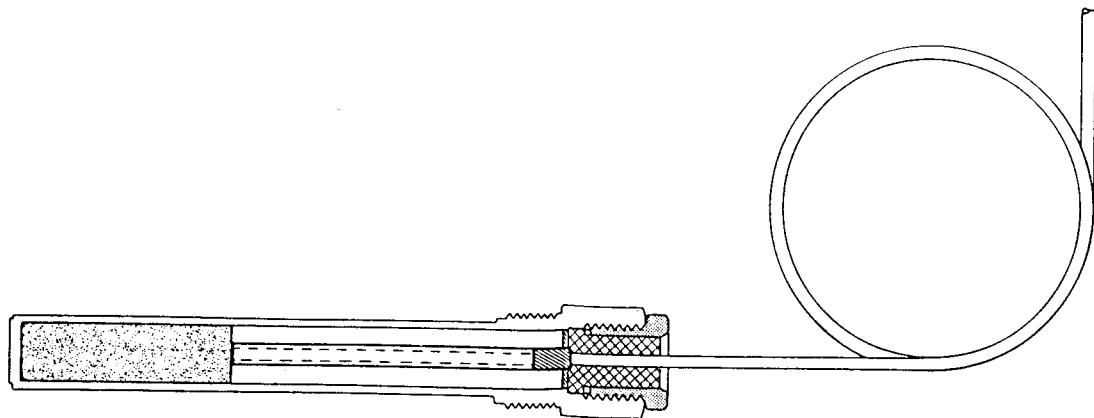

2.

INSTRUCTIONS

060A0570

060A0570

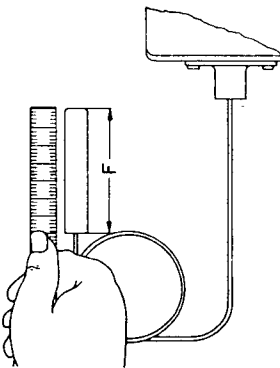
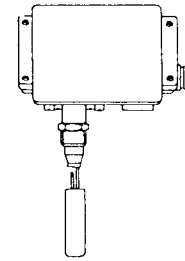
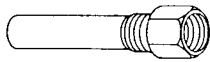
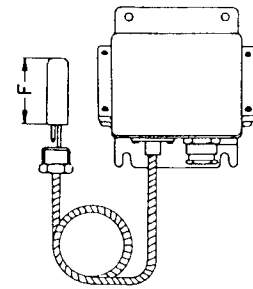
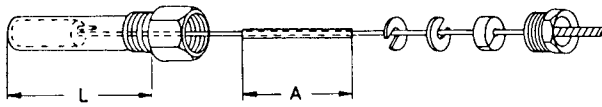
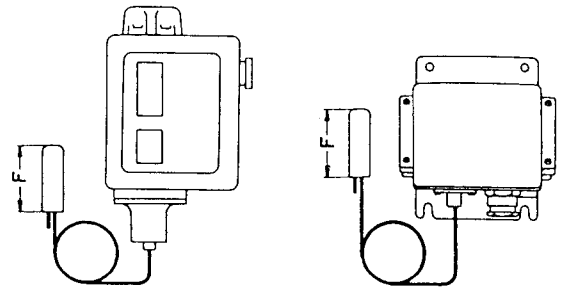
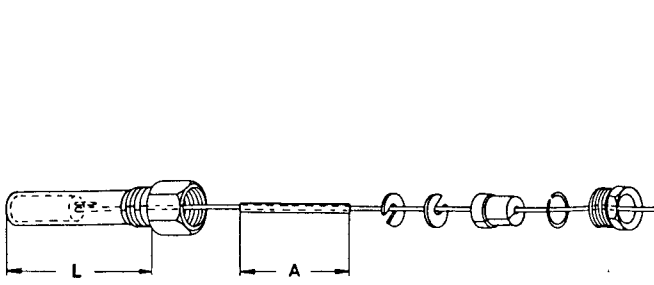

	L = 65	L = 75	L = 110	L = 160
F = 47,5	A = 15	A = 25	A = 60	A = 110
F = 75			A = 33	A = 83
F = 85			A = 23	A = 73

