

a	Manway	17"
b	Outlet	1.5" Tri-Clamp
c	Inlet	1.5" Tri-Clamp
d	Thermocouple Port	1.5" Tri-Clamp
e	Temperature Guage	1.5" Tri-Clamp
f	Vent	
g	Burner Port	4" Flange
h	Chimmney	8"
m	Clean-Out	
Dimensions: 8'4" height 5'9" Diameter, Weight 2000 Lbs. Power Requirements: Natrual Gas Line Total Brew House 208-240V 3 Phase 30 Amps.		

Vessel Specifications			
	Unit	Container	Jacket
Working Pressure	PSI		
Tested Pressure	PSI		
Termerature Range	F	15-260	
Material		SS304	SS304
Full Volume	BBL		
Rated Volume	BBL	20	

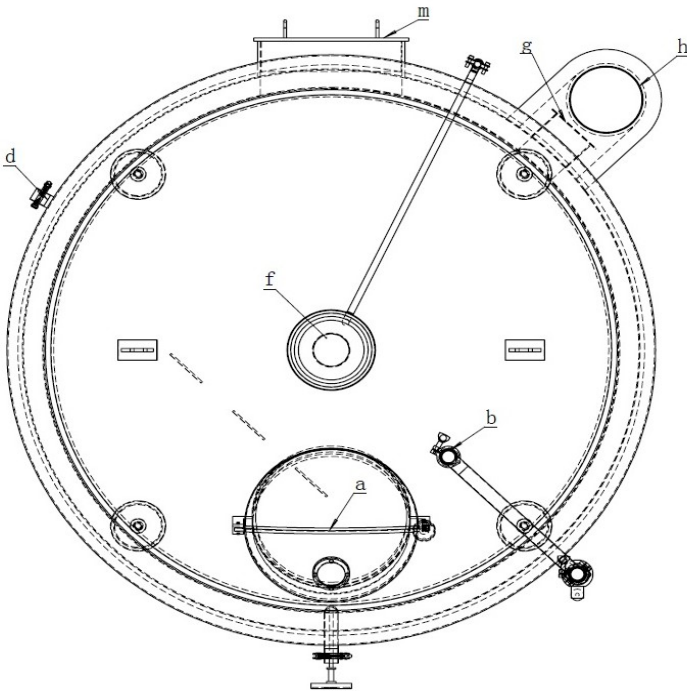
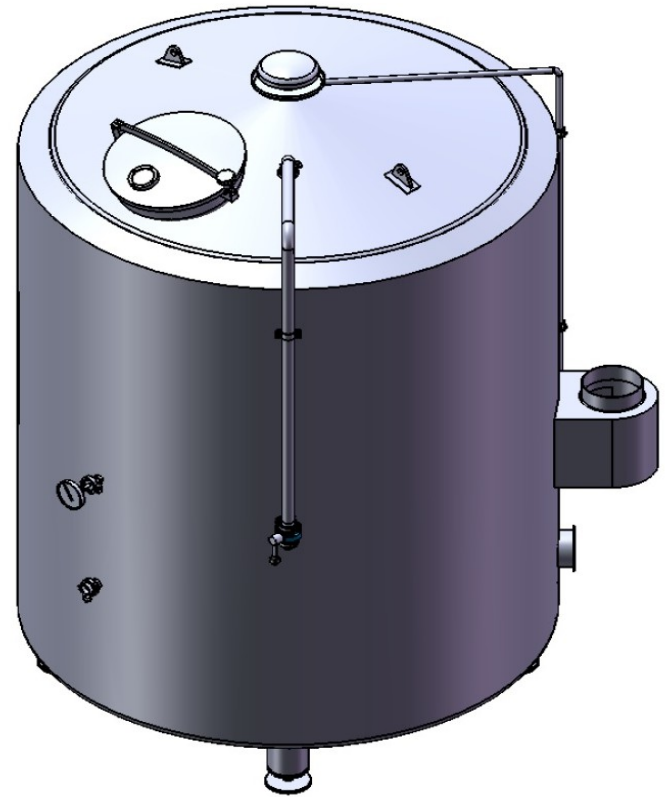

**Atlantic Brew Supply**  
 20 Barrel Direct Fired Hot Liquor Tank  
 Model: HLT20BBLDF